

Data Sheet

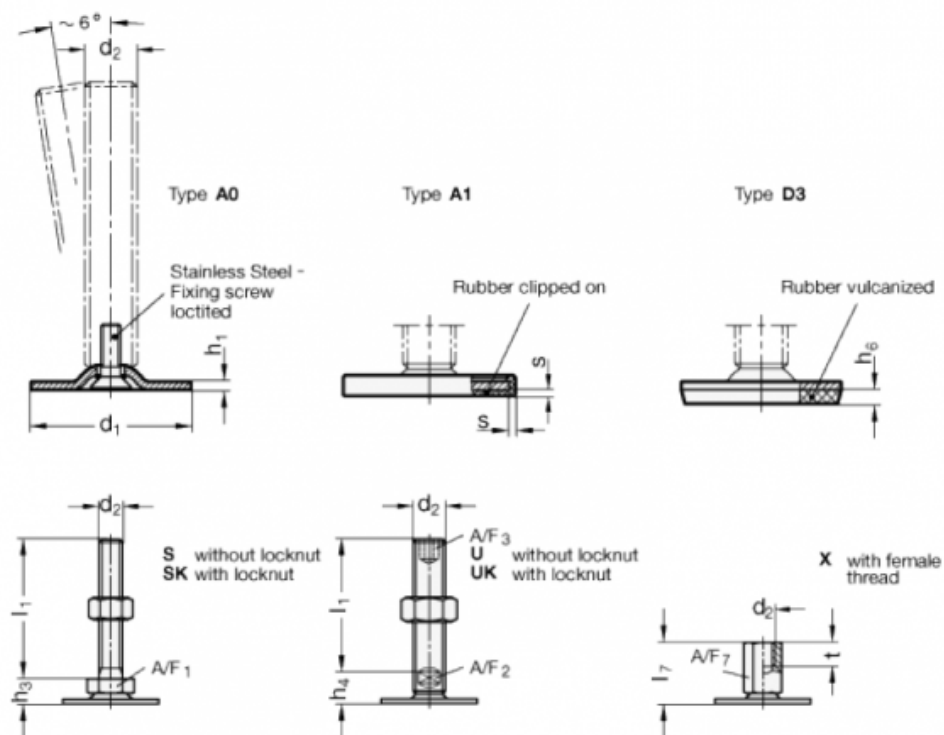

Article number: 204080M1060A3SK
 Description: E+G levelling foot
 GN 40-80-M10-60-A3-SK
 Note: SK With nut, External hexagon at the bottom

Measures



- A/F1 = 17
- d1 = 80
- d2 = M10
- h1 = 3
- h3 = 12
- h6 = 5
- l1 = 60
- s =